

OPERATION MANUAL
FOR DISPLAYS OF SERIES
DT-203NW, DT-105NW AND DT-110NW

1504K03E



TETRALEC E.I. S.L.
Empresa certificada

Index

1 INTRODUCTION.....	1-2
2 GENERAL CHARACTERISTICS.....	2-1
2.1 Electrical characteristics of the displays.....	2-1
2.1.1 Electrical characteristics of the DT-203 displays.....	2-1
2.1.2 Electrical characteristics of the DT-105 displays.....	2-1
2.1.3 Electrical characteristics of the DT-110 displays.....	2-1
2.2 Weight and power consumption. Exterior option use column h(VA).....	2-2
2.3 Dimensions of the displays.....	2-3
3 INSTALLATION.....	3-1
3.1 Power supply.....	3-1
3.2 Connecting the antenna.....	3-1
3.3 Characteristics of temperature & humidity probe. (Option).....	3-2
3.4 Wiring of temperature & humidity probe (Option).....	3-2
3.5 Reset button.....	3-2
4 OPERATION.....	4-1
4.1 Initial Start Up.....	4-1
4.2 Message programming.....	4-1
4.3 Set parameters.....	4-1
4.3.1 Enter to modify parameters.....	4-2
4.3.2 Exit modify parameters.....	4-2
4.3.3 Function of each parameter.....	4-2
4.4 Protocols.....	4-4
4.4.1 Using each protocol.....	4-4
4.4.2 Block Structure.....	4-4
4.4.3 Control characters.....	4-4
4.4.4 Valid characters.....	4-5
4.4.5 TCP/IP Protocol.....	4-5
4.4.6 UDP/IP Protocol:.....	4-5
4.4.7 Modbus/TCP Protocol.....	4-6
4.5 IP Address.....	4-11
4.5.1 Accessing Wifi module configuration.....	4-13
4.6 Set up IP Address using the DeviceInstaller.....	4-16
4.7 Modifying the port settings.....	4-16
4.7.1 Configure to use the UDP/IP protocol.....	4-18
4.7.2 Configure to use the Modbus/TCP protocol.....	4-19

1 INTRODUCTION

The alphanumeric displays for series **DT-203NW**, **DT-105NW** and **DT-110NW** are industrial displays for control by Ethernet network and can be configured for use with TDL, TCP/IP and Modbus/TCP protocols.

The selection of the parameters and the communication protocol is done using two buttons with a system of easily programmable menu.

One of its main characteristics is the large size of the characters,

DT-203NW of **30mm** legible at 15m.

DT-105NW of **50 mm** legible at 25m.

DT-110NW of **100 mm** legible at 50m.

As with other display series, the DT-203NW, DT-105NW, and DT-110NW series is also available in one or two-sided versions, which provides multiple solutions and installation possibilities.

It is surface mounted, with fixtures to a wall or partition wall, or suspended by the side anchoring.

The application field of these displays is very wide in all types of industrial applications utilising the advantages of the Ethernet network. They can be used to display Scada program values, counter values from a PLC, warning messages, advertisements.

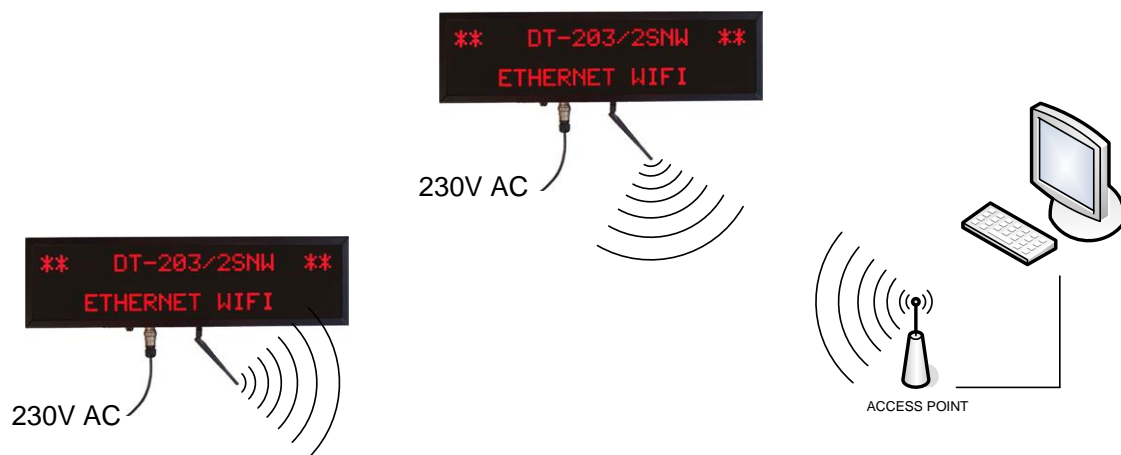

2 GENERAL CHARACTERISTICS.

2.1 Electrical characteristics of the displays

2.1.1 Electrical characteristics of the DT-203 displays.

Supply Voltage	88 to 264 VAC 47 to 63Hz. Option 24VDC.
Consumption	Read chapter 2.2
Display	7x5 Dot matrix of 30mm high.
.....	Red Led colour. Visibility 15 meters.
Parameter memory	Eeprom.
Watch calendar	Second / Minute / Hour / Day / Month / Year.
Communication	IEEE 802.11b and IEEE 802.11g.
Communication Protocols	TCP/IP, TDL and Modbus/TCP.
Environmental Conditions	Operation Temperature: -20 to 60°C.
.....	Storage temperature: -30°C to 70°C.
.....	Humidity: 5-95% without condensation.
.....	Maximum environmental illumination: 1000 lux.
.....	Sealing: IP41, IP54 and IP65.

2.1.2 Electrical characteristics of the DT-105 displays.

Supply Voltage	88 to 264 VAC 47 to 63Hz. Option 24VDC.
Consumption	Read chapter 2.2
Display	7x5 Dot matrix of 50mm high.
.....	Red Led colour. Visibility 25 meters.
Parameter memory	Eeprom.
Watch calendar	Second / Minute / Hour / Day / Month / Year.
Communication	IEEE 802.11b and IEEE 802.11g.
Communication Protocols	TCP/IP, TDL and Modbus/TCP.
Environmental Conditions	Operation Temperature: -20 to 60°C.
.....	Storage temperature: -30°C to 70°C.
.....	Humidity: 5-95% without condensation.
.....	Maximum environmental illumination: 1000 lux.
.....	Sealing: IP41, IP54 and IP65.

2.1.3 Electrical characteristics of the DT-110 displays.

Supply Voltage	88 to 264 VAC 47 to 63Hz. Option 24VDC.
Consumption	Read chapter 2.2
Display	7x5 Dot matrix of 100mm high.
.....	Red Led colour. Visibility 50 meters.
Parameter memory	Eeprom.
Watch calendar	Second / Minute / Hour / Day / Month / Year.
Communication	IEEE 802.11b and IEEE 802.11g.
Communication Protocols	TCP/IP, TDL and Modbus/TCP.
Environmental Conditions	Operation Temperature: -20 to 60°C.
.....	Storage temperature: -30°C to 70°C.
.....	Humidity: 5-95% without condensation.
.....	Maximum environmental illumination: 1000 lux.
.....	Sealing: IP41, IP54 and IP65.

2.2 Weight and power consumption. Exterior option use column h(VA)

Reference	Weight (kg)	Power (VA)	Power h (VA)	Reference	Weight (kg)	Power (VA)	Power h (VA)
DT-105/1S-6	4	12	25	DT-110/1S-6	6,5	12	25
DT-105/1D-6	4	16	46	DT-110/1D-6	7,5	16	46
DT-105/1S-13	5,5	16	46	DT-110/1S-13	10,5	16	46
DT-105/1D-13	6	28	90	DT-110/1D-13	13	28	90
DT-105/1S-20	7	22	68	DT-110/1S-20	14,5	22	68
DT-105/1D-20	8	38	134	DT-110/1D-20	18	38	134
DT-105/1S-26	9	28	90	DT-110/1S-26	19	28	90
DT-105/1D-26	10	50	179	DT-110/1D-26	23,5	50	179
DT-105/1S-33	10,5	34	112	DT-110/2S-6	9	16	48
DT-105/1D-33	12	60	222	DT-110/2D-6	11,5	28	90
DT-105/1S-40	12	38	136	DT-110/2S-13	15	28	90
DT-105/1D-40	14	72	266	DT-110/2D-13	20	50	178
DT-105/2S-6	5	16	48	DT-110/2S-20	21	38	134
DT-105/2D-6	5,5	28	90	DT-110/2D-20	28	72	266
DT-105/2S-13	7	28	90	DT-110/2S-26	27	50	180
DT-105/2D-13	8	50	178	DT-110/2D-26	36,5	92	354
DT-105/2S-20	9	38	134	DT-110/3S-6	12	22	68
DT-105/2D-20	10,5	72	266	DT-110/3D-6	15,5	38	112
DT-105/2S-26	11	50	180	DT-110/3S-13	20	38	136
DT-105/2D-26	13,5	92	354	DT-110/3D-13	27	72	244
DT-105/2S-33	13,5	60	220	DT-110/3S-20	27,5	55	200
DT-105/2D-33	16	115	442	DT-110/3D-20	38,5	105	376
DT-105/2S-40	15,5	72	266	DT-110/3S-26	35,5	72	266
DT-105/2D-40	19	138	530	DT-110/3D-26	49,5	138	510
DT-105/3S-6	5,5	22	68	DT-110/4S-20	34	72	268
DT-105/3D-6	6,5	38	112	DT-110/4D-20	48,5	138	486
DT-105/3S-13	8,5	38	136	DT-110/5S-20	41	88	330
DT-105/3D-13	10	72	244	DT-110/5D-20	58	170	600
DT-105/3S-20	11	55	200	DT-110/6S-20	47,5	105	400
DT-105/3D-20	13,5	105	376	DT-110/6D-20	68,5	204	700
DT-105/3S-26	13,5	72	266	DT-110/7S-20	53,5	120	465
DT-105/3D-26	17	138	510	DT-110/7D-20	78,5	240	820
DT-105/3S-33	16	90	332	DT-110/8S-20	60	140	530
DT-105/3D-33	20,5	170	640	DT-110/8D-20	88,5	280	930
DT-105/3S-40	18,5	105	400	DT-203/2S-20	6	35	----
DT-105/3D-40	24	205	770	DT-203/2D-20	6,5	60	----
DT-105/4S-20	12,5	72	268	DT-203/2S-40	9	60	----
DT-105/4D-20	16	138	486	DT-203/2D-40	10,5	120	----
DT-105/5S-20	14,5	88	330	DT-203/4S-20	7,5	60	----
DT-105/5D-20	18,5	170	600	DT-203/4D-20	9	120	----
DT-105/6S-20	16,5	105	400	DT-203/4S-40	12	120	----
DT-105/6D-20	21,5	204	700	DT-203/4D-40	15	240	----
DT-105/7S-20	18	120	465	DT-203/6S-20	9	90	----
DT-105/7D-20	24	240	820	DT-203/6D-20	11,5	180	----
DT-105/8S-20	20	140	530	DT-203/8S-20	11	120	----
DT-105/8D-20	27	280	930	DT-203/8D-20	14	240	----

2.3 Dimensions of the displays

	A	B	C	D	E	F	G	P1	P2	P3
DT-105/1S(D)-6	375	118	109	X	X	X	358	O	X	X
DT-105/1S(D)-13	680	118	109	X	X	X	663	O	X	X
DT-105/1S(D)-20	985	118	109	X	X	X	968	O	X	X
DT-105/1S(D)-26	1290	118	109	X	X	X	1273	O	X	X
DT-105/1S(D)-33	1595	118	109	X	X	X	1578	O	X	X
DT-105/1S(D)-40	1900	118	109	X	X	X	1883	O	X	X
DT-105/2S(D)-6	375	230	112	X	X	X	358	O	X	X
DT-105/2S(D)-13	680	230	112	X	X	X	663	O	X	X
DT-105/2S(D)-20	985	230	112	X	X	X	968	O	X	X
DT-105/2S(D)-26	1290	230	112	X	X	X	1273	O	X	X
DT-105/2S(D)-33	1595	230	112	X	X	X	1578	O	X	X
DT-105/2S(D)-40	1900	230	112	X	X	X	1883	O	X	X
DT-105/3S(D)-6	375	338	X	72	186	X	358	X	O	O
DT-105/3S(D)-13	680	338	X	72	186	X	663	X	O	O
DT-105/3S(D)-20	985	338	X	72	186	X	968	X	O	O
DT-105/3S(D)-26	1290	338	X	72	186	X	1273	X	O	O
DT-105/3S(D)-33	1595	338	X	72	186	X	1578	X	O	O
DT-105/3S(D)-40	1900	338	X	72	186	X	1883	X	O	O
DT-105/4S(D)-20	985	436	X	72	292	X	968	X	O	O
DT-105/5S(D)-20	985	542	X	92	358	X	968	X	O	O
DT-105/6S(D)-20	985	648	X	112	424	X	968	X	O	O
DT-105/7S(D)-20	985	754	377	72	610	305	968	O	O	O
DT-105/8S(D)-20	985	860	430	72	716	358	968	O	O	O
DT-110/1S(D)-6	666	177	82,5	X	X	X	649	O	X	X
DT-110/1S(D)-13	1276	177	82,5	X	X	X	1259	O	X	X
DT-110/1S(D)-20	1886	177	82,5	X	X	X	1869	O	X	X
DT-110/1S(D)-26	2496	177	82,5	X	X	X	2479	O	X	X
DT-110/2S(D)-6	666	378	X	80	218	X	649	X	O	O
DT-110/2S(D)-13	1276	378	X	80	218	X	1259	X	O	O
DT-110/2S(D)-20	1886	378	X	80	218	X	1869	X	O	O
DT-110/2S(D)-26	2496	378	X	80	218	X	2479	X	O	O
DT-110/3S(D)-6	666	591	X	80	430	X	649	X	O	O
DT-110/3S(D)-13	1276	591	X	80	430	X	1259	X	O	O
DT-110/3S(D)-20	1886	591	X	80	430	X	1869	X	O	O
DT-110/3S(D)-26	2496	591	X	80	430	X	2479	X	O	O
DT-110/4S(D)-20	1886	805	403	80	646	322,5	1869	O	O	O
DT-110/5S(D)-20	1886	1018	509	80	858	429	1869	O	O	O
DT-110/6S(D)-20	1886	1232	616	80	1072	536	1869	O	O	O
DT-110/7S(D)-20	1886	1445	723	80	1286	643	1869	O	O	O
DT-110/8S(D)-20	1886	1654	830	80	1500	750	1869	O	O	O
DT-203/2S(D)-20	615	177	85	X	X	X	598	O	X	X
DT-203/2S(D)-40	1170	177	85	X	X	X	1153	O	X	X
DT-203/4S(D)-20	615	317	X	72	173	X	598	X	O	O
DT-203/4S(D)-40	1170	317	X	72	173	X	1153	X	O	O
DT-203/6S(D)-20	615	464	X	91	282	X	598	X	O	O
DT-203/8S(D)-20	615	611	X	112	387	X	598	X	O	O

See the draw on the next page

Measures in millimeters. X = Not valid for these model.

P1, P2 and P3: Anchorage point. Used = O. Not used = X. Anchorage holes position on the wall. See valid point (P1, P2 o P3) on the table in the previous page.

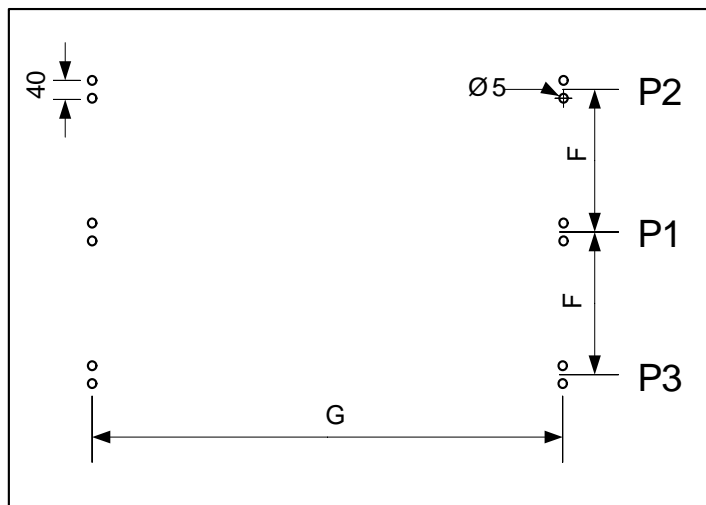
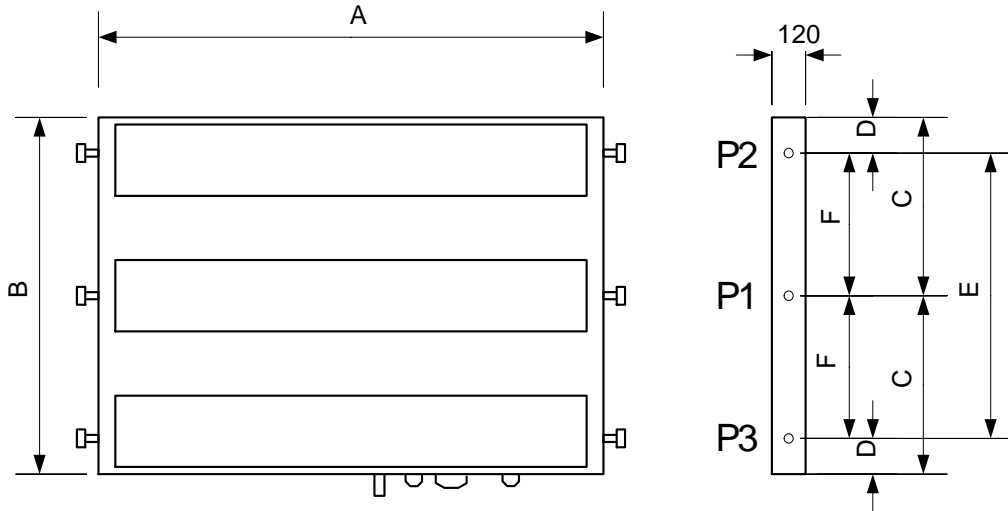

3 INSTALLATION.

The installation of the **DT-203**, **DT-105** y **DT-110**, is not particularly delicate but some important considerations must be taken into account.

It must not be anchored to places subject to vibrations, nor should it be installed in places which generally surpass the limits specified in the display characteristics, both in terms of temperature and humidity.

The degree of protection of displays **DT-203**, **DT-105** and **DT-110** is IP41, meaning that they are protected against penetration by solid foreign objects of a diameter of about 1mm and against the vertical fall of water droplets. The **DT-203f**, **DT-105f** and **DT-110f** are IP54, which mean that are more protected. **DT-203e**, **DT-105e** and **DT-110e** are IP65.

Displays **DT-203**, **DT-105** and **DT-110**, should not be installed in places with illumination level higher than 1000 lux. Neither should the display be placed in direct sunlight as visibility would be lost. Displays **DT-105h** and **DT-110h** can be read in sunlight.

In the electrical installation, proximity to lines of high intensity circulation and high voltage lines must be avoided, as well as proximity to High Frequency generators and U/F converters for motors.

3.1 Power supply.

The power supply must be 88 to 264 VAC 47 to 63Hz or 19 to 36VDC or 24VDC with the option 24V.

The power supply conductor section will be in line with consumption and the ground conductor will be a minimum section of 1.5mm².

The power supply connector for 220VAC has 3 contacts and is situated in the lower part of the unit. Connect the power wires following the schema below

The power supply connector for 24VDC has 4 contacts and is situated in the lower part of the unit. Connect the power wires following the schema below

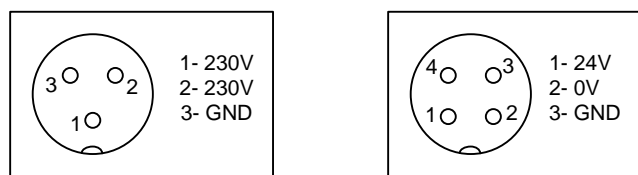

3.2 Connecting the antenna.

Wifi connection is carried out using an antenna located in the lower part of the unit.



3.3 Characteristics of temperature & humidity probe. (Option)

Relative humidity

Resolution Typical 1%.
Accuracy $\pm 3,5\%$ between 30% and 70%.
Warm-up time 4s.

Temperature

Resolution Typical 0,1°C.
Accuracy $\pm 0,5^\circ\text{C}$ at 25°C.
Warm-up time 20s.
Range From -20°C to $+80^\circ\text{C}$.

3.4 Wiring of temperature & humidity probe (Option)

The temperature & humidity probe is delivered with 5m cable and a Sub-D9 connector ready to use.

The wiring of connector probe is shown in the diagram (cable connector).

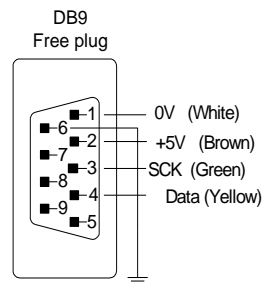

3.5 Reset button

If the computer has been out of power for many days, the battery may be discharged. If, when the power is restored, the battery is not fully charged, it may be necessary to force the device to be reset. The reset button is next to the power connector. The display must be connected to the power supply for the reset to be operative.

4 OPERATION

4.1 Initial Start Up.

Before connecting the display to the network, we must ensure that all of the connections have been carried out correctly and that the display is firmly in place.

Every time the display is connected to the power supply there is an initial reset, which checks all points of the display. After the initial reset the version code is displayed.

Following the initial reset, the display reads the message memory and initialises the messages table. The word "INICI" is shown until the display is prepared to receive messages.

When the initialisation process is finished, the display is ready to receive data. While waiting for the first message the display shows a programmed message on the memory.

4.2 Message programming.

In order to program the messages in the memory Eeprom, a PC and the TDLWin Version later than 1.5, specifically designed to program the messages into the display. Usually you may program only the message 0 because after initialisation this is the message displayed.

To program the messages, you must program the following parameters:

- Display : Parameter Protocol = TDL
- Local Port = 10001. Use Device Installer software to modify.

- Software TDLWin
- Serial line = TCP/IP
- IP Address = Display Address.

4.3 Set parameters.

Before using the display the user must set the parameters:

The parameters are:

- 1- Language of menu
- 2- Protocol.
- 3- End of block code.
- 4- Response message.
- 5- MAC code.
- 6- Load the default configuration to the Ethernet port.
- 7.- Wi-fi configuration.
- 8- Display's date.
- 9- Display's time.
- 10- Level of Leds luminosity.
- 11- End menu.

To set the parameters, the display has a pair of pushbuttons located at the bottom of the case. The menu is in four languages.

4.3.1 Enter to modify parameters.

In order to enter the sequence to modify the parameters, the Advance key “*” must be pressed and held for three seconds. After this, the first parameters will be displayed, with the digit flashing.

There are then two options:

Modify the parameter value

By pressing the Advance key “*”, entry is gained to modify the parameter value.

To go back to displaying the parameter number, press “*” again.

To increase the parameter value, press the “+” key. After parameter EXIT it returns to parameter LANGUAGE.

Select another parameter

In order to select another parameter, the parameter number must be made to flash using the “*” key and then the new parameter may be selected using the “+” key.

4.3.2 Exit modify parameters.

In order to exit the sequence for modifying parameters, parameter EXIT must be selected then press “*”.

4.3.3 Function of each parameter.

4.3.3.1 Parameter LANGUAGE or LA.

The language menu. There are four languages available: Catalan, Spanish, French and English.

4.3.3.2 Parameter PROTOCOL or PR.

The selected protocol. The protocols available are:

- TDL To program message with TDLWin.
- TCP/UDP: To be used with TCP/IP or UDP/IP.
- Modbus/TCP: To be used with Modbus/TCP.

Before using TCP/IP, UDP/IP or Modbus/TCP protocols you must set up the Ethernet port using the DeviceInstaller software (available from Lantronix web).

4.3.3.3 Parameter END BLOCK or EB. Only TCP/IP and UDP/IP protocols.

Allows for code selection to indicate that the block has been completely sent. The options are the following, as displayed:

End of block	
20 or + characters	6 or 13 characters
0x0D	0D
0x0A	0A
0x0D 0x0A	D+A
0x0A 0x0D	A+D
0x03	03
0x02	02
0x2A 0x0D	*+D
0x04	04

4.3.3.4 Parameter REPLAY or R. Only TCP/IP and UDP/IP protocols.

For configuring the display's response message.

20 or + Characters	6 or 13 characters	Response message
NO	NO	Without replay
0x06+EB	06+EB	0x06 + End of block
ACK + EB	AC + EB	ACK + End of block
0x06	0x06	0x06
ACK	ACK	ACK

End of block is the one selected in parameter 3.

If value "06 + EB" has been selected, the hexadecimal code 06 is sent, followed by the block selected in parameter 2

If value "ACK + EB" has been selected, the ACK characters are sent followed by the block selected in parameter 2.

4.3.3.5 Parameter MAC or MA Code

The MAC code is a code which identifies each port which connects to an Ethernet network. It is unique to each unit and is needed to configure the port.

The MAC code is formed by 6 bytes in a hexadecimal format.

Example: MA: 00-20-4A-8A-E5-6C

4.3.3.6 Parameter RESET XPORT or RX

If the configuration of the port has been modified and the factory parameters cannot be reset, this parameter can be used to load them.

To load the factory parameters, value 999 must be input and the advance key "7->5" pressed. During the parameter loading time, a waiting message is displayed. After resetting the port the blinking message RESET XPORT is displayed.

4.3.3.7 Parameter CONFIG WIFI

Set up the IP address using the serial port. To set up the IP address you may use the serial line and a computer with the Hyperterminal. See 4.5 "IP Address".

4.3.3.8 Parameter DATE or DA.

Allows you to modify the display date.

4.3.3.9 Parameter TIME or TI.

Allows you to modify the display time.

4.3.3.10 Parameter BRIGHTNESS or BRI.

Allows you to modify the display brightness. Level 1 is the minimum brightness while level 8 is the maximum brightness.

4.3.3.11 Parameter EXIT

To exit modify parameter menu, push advance key ("**").

4.4 Protocols

In this paragraph, the different protocols will be explained, as well as the programming of the displays through them. The formats of values of the numbers and characters are written in this manual are:

- When telling about a hexadecimal number, this will be followed by an “h”.
- When telling about a decimal number, this will be followed by a “d”.
- When telling about a binary number, this will be followed by a “b”.
- When telling about an ASCII character, this will be explained in the context.

As an example, the X ASCII character can be explained as 58h, 88d or 1011000b, as needed in the moment. Number 15 ASCII can be seen as 31h 35h, 49d 53d or 110001d 110101d.

4.4.1 Using each protocol

TDL protocol: This protocol is used only to read or write messages in the internal memory of the display or change its time/date

TCP/IP and UDP/IP: These allow the user to send the complete text that must be displayed or to activate a message from the memory. If the message contents variables, the values cannot be loaded.

ModBus/TCP: This protocol allows the user to activate messages from the memory, with or without variables and to send complete messages. It uses the function 06h and 10h.

4.4.2 Block Structure.

In order for the display to be able to accept a block, it must end with an end of block that is recognised by the display. The end of block coding which the display expects to receive can be found in 4.3.3.3 “Parameter END BLOCK or EB. Only TCP/IP and UDP/IP protocols.”

4.4.3 Control characters.

Control characters are used in conjunction with valid characters to extend the edition capabilities. The extension includes display variables, blinking characters, set timer, modify brightness.

- 8 (08h) Beginning of blinking, in the following characters.
- 9 (09h) Ending of blinking.
- 10(0Ah) Line feed. The same as code 12(0Ch). **Not compatible with End Block = 0x0A**
- 11(0Bh) + Line number. Jump to line number in ASCII.
- 12(0Ch) Line feed. The same as code 10(0Ah).
- 18(12h) + n. Brightness control. n in ASCII. n = 1 Minimum. n = 8 Maximum.
- 21(15h) Displaying the date. DD/MM/YY
- 22(16h) Displaying hour and minutes. HH:MM
- 23(17h) Displaying the date. DD/MM/YYYY
- 24(18h) Displaying hour, minutes and seconds. HH:MM:SS
- 25(19h) Setting time and date.
 - 25 DDMMYYxHHMM x = Blank space. (20h)
- 29(1Dh) Display all the messages from memory.
- 31(1Fh) To display a message from internal memory. After the control character the message number must be send in ASCII code. Example:
 - Display message 6: 1F 36
 - Display message 218: 1F 32 31 38

Only with humidity and temperature option present.

- 26(1Ah) Displaying temperature in Celsius. Format: $\pm CC.C^\circ$
- 27(1Bh) Displaying temperature in Fahrenheit. Format: $\pm FF.F^\circ$
- 28(1Ch) Displaying relative humidity. Format HH%
- 30(1Eh) Read the temperature and humidity from the display. Only TCP/IP and UDP/IP.
Received block: CCC.CxxFFF.FxHH
C = Temperature in Centigrade.
F = Temperature in Fahrenheit.
H = Humidity.
x = Blank space (20h)

4.4.4 Valid characters.

Alphanumerical displays can display all the alphabet characters, numbers and some special characters. The table in the next page shows all the valid characters. ASCII code in hexadecimal is used.

	0	1	2	3	4	5	6	7	8	9	A	B	C	D	E	F
0																
1									↑	↓	→	←		.	▲	▼
2		!	"	#	\$	%	&	'	()	*	+	,	-	.	/
3	0	1	2	3	4	5	6	7	8	9	:	;	<	=	>	?
4	@	A	B	C	D	E	F	G	H	I	J	K	L	M	N	O
5	P	Q	R	S	T	U	V	W	X	Y	Z	[\]	↑	←
6	`	a	b	c	d	e	f	g	h	i	j	k	l	m	n	o
7	p	q	r	s	t	u	v	w	x	y	z	£	¥	½	-	△
8	Ç	ü	é	â	ä	à	å	ç	ê	ë	è	ï	î	ì	Ä	Å
9	É	æ	Æ	ô	ö	ò	û	ù	ÿ	Ö	Ü	ø	£	Ø	€	f
A	á	í	ó	ú	ñ	Ñ	ª	º	¿		¬			¡	«	»
B							↓	↑	→	←	→	←	-	-		
C														=		
D																
E	α	β														
F		±	≥	≤					°							

4.4.5 TCP/IP Protocol.

In order to use TCP/IP protocol, the communication port must be programmed with the default configuration. See 4.3.3.6 "Parameter RESET XPORT or RX".

The Local Port must be = 10001.

To set up the Local Port, use the Device Installer software.

4.4.6 UDP/IP Protocol:

In order to use UDP protocol, you must set up the parameters port with the default configuration (See 4.3.3.6 "Parameter RESET XPORT or RX") excepting the following parameters:

UDP Datagram Mode

Datagram Type which must be set to **01**.

Endpoint Configuration

Remote Host: IP address of the computer to which it is connected.

Remote Port: Port of the computer to which it is connected.

The Local Port must be = 10001.

To set up de Local Port, use the Device Installer software.

4.4.7 Modbus/TCP Protocol.

In order to use Modbus/TCP protocol, the communication port must be programmed with the default configuration. See 4.3.3.6 “Parameter RESET XPORT or RX”.

The Local Port must be = 502.

To set up de Local Port, use the Device Installer software.

The data block transmitted must have the following values:

Byte 6. Slave ID = 01h.

Message control: The ModBus protocol allows two ways for displaying messages:

Send the complete message.

The address is 0000h (40001) and the data must be sent in ASCII format. The available characters are shown in 4.4.4.

Activate a message from the internal memory

The messages in the internal memory are classified as messages with variables and messages without variables. All messages must be edited and loaded on the display using the TDLWin program.

Messages without variables: These are the messages which are shown as they were edited. All the commands of the menu “orders” in TDLWin can be used, excepting the variable code [V].

The memory area to activate the 6 messages without variables is:

40402	40403	40404	40405	40406	40407
191h	192h	193h	194h	195h	196h

To activate a message the user must write the the message number in any of the 6 memory positions (191h to 196h)

To deactivate a message a 0 must be written in the same position where the message was activated. If all the memory positions are 0, the 0 message is shown.

4.4.7.1 Messages with variables

These messages have the same specifications than the messages without variables plus the variable displaying function. These variables must be programmed in the messages using the program TDLWin. The user must access the “orders” menu and select [V] or press F4. Each [V] code is a variable character.

The number of characters occupied depends on the type of variable shown. The different variables that can be used, the maximum and minimum values and the number of characters occupied per variable are shown below.

Variable type	Minimum value	Maximum value	Type code	Max line	per	Occupied characters
Signed byte	-128	127	1	4		4
Unsigned byte	0	255	2	5		3
Signed Word	-32768	32767	3	2		6
Unsigned Word	0	65535	4	3		5
Signed DWord	-2147483648	2147483647	5	1		11
Unsigned DWord	0	4294967295	6	1		10
ASCII			7	16		1

The displays DT-xx/NE can be from 1 to 8 lines and so, the messages can be 1 to 8 lines too.

One or two messages with variables can be activated, independently from the messages without variables. The memory positions of the messages with variables are 19Ah and 1FEh.

To activate a variable, the type and the number of the variables occupied in the line must be specified. There can be 16 variable characters activated per line, all of the same type. Depending on the type of variable, there can be programmed between 1 and 16 variables per line

To activate a message with variables, the message code must be loaded in the memory position 19Ah or 1FEh. The variable type and the number of variables occupied must be specified in memory positions 19Bh or 1FFh. Do not confuse with the number of characters occupied.

The TYPE/NUM register (19Bh or 1FFh) is made of two bytes. The upper height is the code of the variable (as seen in the table before). The lower high tells the number of variables to be read.

As an example, there can be 2 variables of type 3 (word unsigned) programmed. This is because each variable occupies 6 characters and the maximum is 16 characters per line.

Example:

Pieces [V][V][V] Hours: [V][V][V]	TYPE/NUM (19Bh or 1FFh) = 02 02h
Pieces [V][V][V][V][V][V]	TYPE/NUM (19Bh or 1FFh) = 03 01h
Pieces [V][V][V][V] Hours: [V][V][V][V]	TYPE/NUM (19Bh or 1FFh) = 01 02h
Pieces [V][V][V][V][V]	TYPE/NUM (19Bh or 1FFh) = 04 01h
Pieces [V][V][V][V][V][V][V][V]	TYPE/NUM (19Bh or 1FFh) = 07 08h

LINE 1	CODE	TYPE/NUM		VALUES						
		40411	40412	40413	40414	40415	40416	40417	40418	40419
	19Ah	19Bh	19Ch	19Dh	19Eh	19Fh	1A0h	1A1h	1A2h	1A3h

LINE 1	CODE	TYPE/NUM		VALUES						
		40511	40512	40513	40514	40515	40516	40517	40518	40519
	1FEh	1FFh	200h	201h	202h	203h	204h	205h	206h	207h

The values field must be loaded with the values of the variables.

Depending on the type of variable, the values will occupy:

- Byte and word: Each variable occupies a memory word.
- Dword: Each variable occupies two memory words.
- ASCII: 2 characters occupy a word.

The memory positions of the two variable messages are shown below

Message 1:

LINE	CODE	TIPE/ NUM	VALUES							
	LINE 1	40411 19Ah	40412 19Bh	40413 19Ch	40414 19Dh	40415 19Eh	40416 19Fh	40417 1A0h	40418 1A1h	40419 1A2h
LINE 2		40422 1A5h	40423 1A6h	40424 1A7h	40425 1A8h	40426 1A9h	40427 1AAh	40428 1ABh	40429 1ACh	40430 1ADh
LINE 3		40432 1AFh	40433 1B0h	40434 1B1h	40435 1B2h	40436 1B3h	40437 1B4h	40438 1B5h	40439 1B6h	40440 1B7h
LINE 4		40442 1B9h	40443 1BAh	40444 1BBh	40445 1BCh	40446 1BDh	40447 1BEh	40448 1BFh	40449 1C0h	40450 1C1h
LINE 5		40452 1C3h	40453 1C4h	40454 1C5h	40455 1C6h	40456 1C7h	40457 1C8h	40458 1C9h	40459 1CAh	40460 1CBh
LINE 6		40462 1CDh	40463 1CEh	40464 1CFh	40465 1D0h	40466 1D1h	40467 1D2h	40468 1D3h	40469 1D4h	40470 1D5h
LINE 7		40472 1D7h	40473 1D8h	40474 1D9h	40475 1DAh	40476 1DBh	40477 1DCh	40478 1DDh	40479 1DEh	40480 1DFh
LINE 8		40482 1E1h	40483 1E2h	40484 1E3h	40485 1E4h	40486 1E5h	40487 1E6h	40488 1E7h	40489 1E8h	40490 1E9h

Message 2

LINE	CODE	TIPE/ NUM	VALUES							
	LINE 1	40511 1FEh	40512 1FFh	40513 200h	40514 201h	40515 202h	40516 203h	40517 204h	40518 205h	40519 206h
LINE 2		40522 209h	40523 20Ah	40524 20Bh	40525 20Ch	40526 20Dh	40527 20Eh	40528 20Fh	40529 210h	40530 211h
LINE 3		40532 213h	40533 214h	40534 215h	40535 216h	40536 217h	40537 218h	40538 219h	40539 21Ah	40540 21Bh
LINE 4		40542 21Dh	40543 21Eh	40544 21Fh	40545 220h	40546 221h	40547 222h	40548 223h	40549 224h	40550 225h
LINE 5		40552 227h	40553 228h	40554 229h	40555 22Ah	40556 22Bh	40557 22Ch	40558 22Dh	40559 22Eh	40560 22Fh
LINE 6		40562 231h	40563 232h	40564 233h	40565 234h	40566 235h	40567 236h	40568 237h	40569 238h	40570 239h
LINE 7		40572 23Bh	40573 23Ch	40574 23Dh	40575 23Eh	40576 23Fh	40577 240h	40578 241h	40579 242h	40580 243h
LINE 8		40582 245h	40583 246h	40584 247h	40585 248h	40586 249h	40587 24Ah	40588 24Bh2	40589 24Ch	40590 24Dh

Example: 2 lines display

Message 16. Edited text:

L1 = [V][V][V][V][V] [V][V][V][V][V]
L2 = [V][V][V] [V][V][V] [V][V][V] [V][V][V]

Message to display:

L1 = 36274 2
L2 = 21 52 129 254

Send:

Identif	Protocol	Number of bytes	Slave	Function	Start address	Number of Registers	Number of Bytes
00h 16h	00h 00h	00h 2Fh	01h	10h	01h 9Ah	00h 14h	28h

	Message	T/NUM	Value 1	Value 2	Value 3	Value 4	Value 5	Value 6	Value 7	Value 8
Line 1	00h 10h	04h 02h	8Dh B2h	00h 02h	00h 00h	00h 00h	00h 00h	00h 00h	00h 00h	00h 00h
Line 2	00h 00h	02h 04h	00h 15h	00h 34h	00h 81h	00h FEh	00h 00h	00h 00h	00h 00h	00h 00h

To activate this message the message with variable 1 has been used. Address 19Ah. The values can be loaded using the function 10h (all together) or with the function 06h (once each time)

Example: 1 line display

Message 21. Edited text:

DWord [V][V][V][V][V][V][V][V][V][V]

Message to display:

DWord 29891983

Send:

Identif	Protocol	Number of bytes	Slave	Function	Start address	Number of Registers	Number of Bytes
00h 24h	00h 00h	1Bh	01h	10h	01h 9Ah	00h 0Ah	14h

	Message	T/NUM	Value 1	Value 2	Value 3	Value 4	Value 5	Value 6	Value 7	Value 8
Line 1	00h 15h	05h 01h	01h C8h	1Dh 8Fh	00h 00h	00h 00h	00h 00h	00h 00h	00h 00h	00h 00h

The length of the block can change depending on the data sent. The following block obtains the same result as the one before.

Identif	Protocol	Number of bytes	Slave	Function	Start address	Number of Registers	Number of Bytes
00h 24h	00h 00h	1Bh	01h	10h	01h 9Ah	00h 0Ah	14h

	Message	T/NUM	Value 1	Value 2
Line 1	00h 15h	05h 01h	01h C8h	1Dh 8Fh

Example: 1 line display

Message 21. Edited text:

ASC [V][V][V][V][V][V][V][V][V][V][V][V][V][V][V]

Message to display:

ASC A1B2C3D4E5F6G7H8

Send:

Identif	Protocol	Number of bytes	Slave	Function	Start address	Number of Registers	Number of Bytes
01h 3Ah	00h 00h	1Bh	01h	10h	01h 9Ah	00h 0Ah	14h

	Message	T/NUM	Value 1	Value 2	Value 3	Value 4	Value 5	Value 6	Value 7	Value 8
Line 1	00h 14h	07h 08h	41h 31h	42h 32h	43h 33h	44h 34h	45h 35h	43h 36h	47h 37h	48h 38h

In this block, the ASCII code has been used.

Example: Load the time and date in the display. It loads 15/09/11 10:27

Send:

Identif	Protocol	Number of bytes	Slave	Function	Start address	Number of Registers	Number of Bytes
00h 00h	00h 00h	13h	01h	10h	00h 00h	00h 06h	0C

Value 1	Value 2	Value 3	Value 4	Value 5	Value 6
19h 31h	35h 30h	39h 31h	31h 20h	31h 30h	32h 37h

When modifying the time, seconds are written to 0

4.5 IP Address

The easiest way to set up the IP address is by using the Hyperterminal program and the serial line of computer. The cable's wiring diagram is the classic crossover.

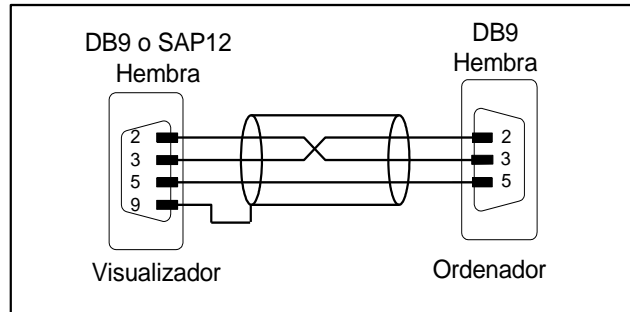

The configuration of the Hyperterminal must be:

- Baud rate: 9600 Bauds
- Data Bits: 8
- No parity
- Stop Bits: 1
- Hardware flow control: None.

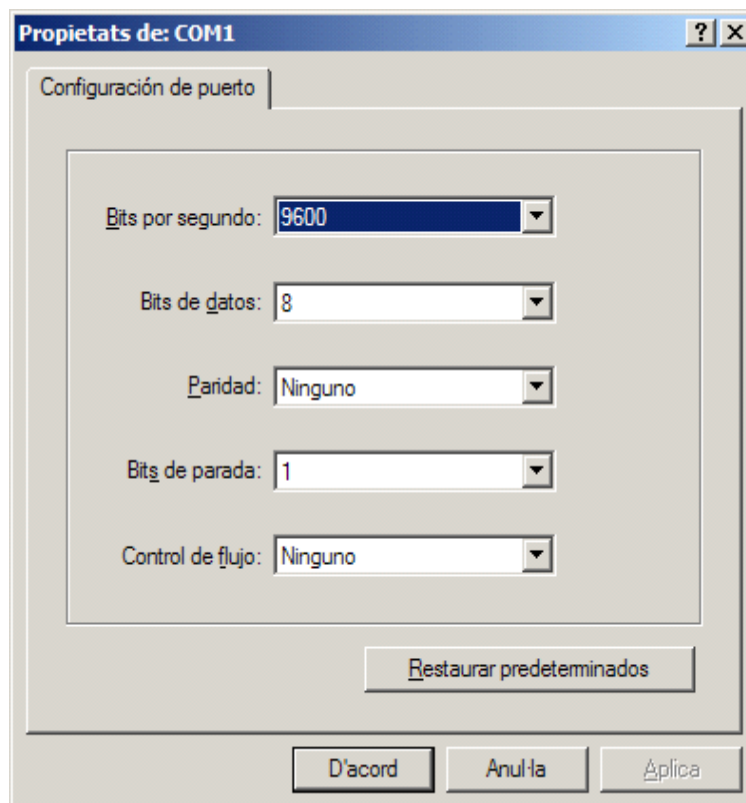

The attached Hyperterminal set up has been verified and works correctly, but any other set up may work also correctly.

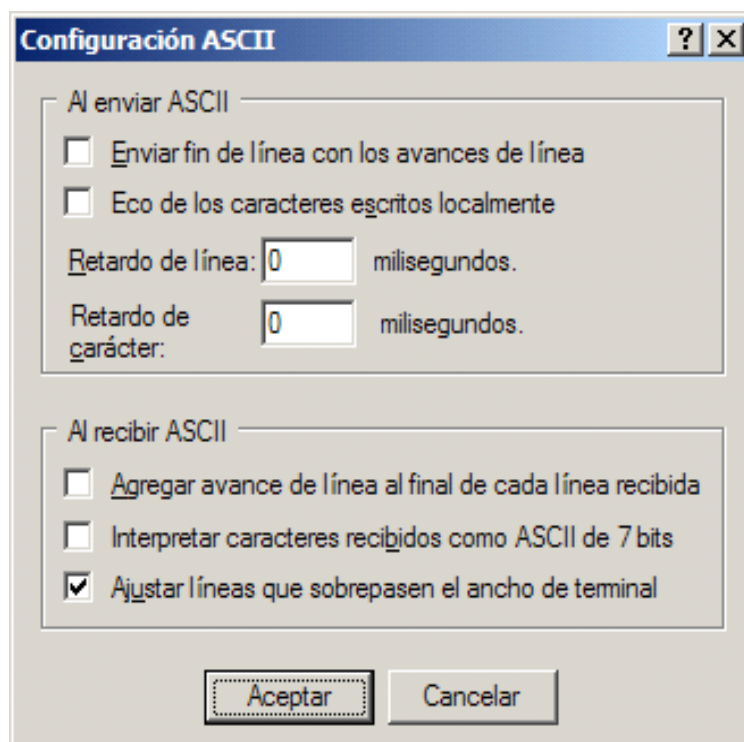
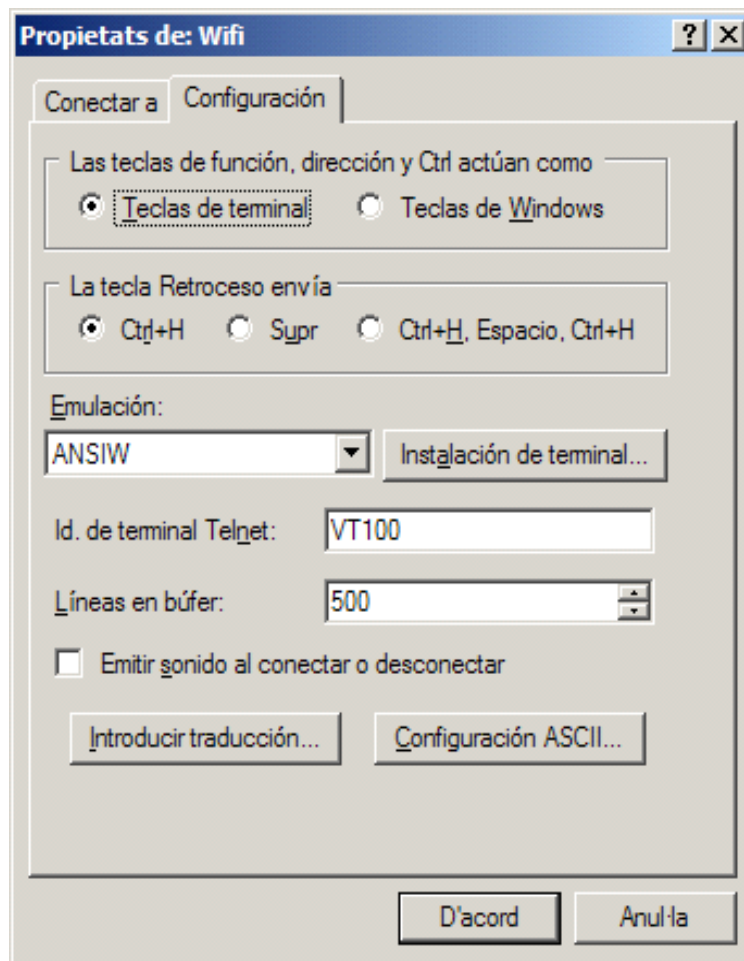

To set up the Wifi module using the Hyperterminal or any other program, you must follow a time sequence. A time error on steps 5 and 6 forces to return to step 3.

4.5.1 Accessing Wifi module configuration

In order to access to Wifi module configuration the next steps must be followed:

- 1- Connect the serial cable (see 4.4) between the computer and the display.
- 2- Open Hyperterminal.
- 3- Select the display's parameter 7. See 4.3.3.7 "Parameter CONFIG WIFI"
- 4- Push the advance key. (Key *)
- 5- Keep pushed the lower case letter **x** before the display counters equals 0. Remain pushing until the following screen is displayed.

The maximum delay since to push the advance key (step 4) until to push x key is 10 seconds.

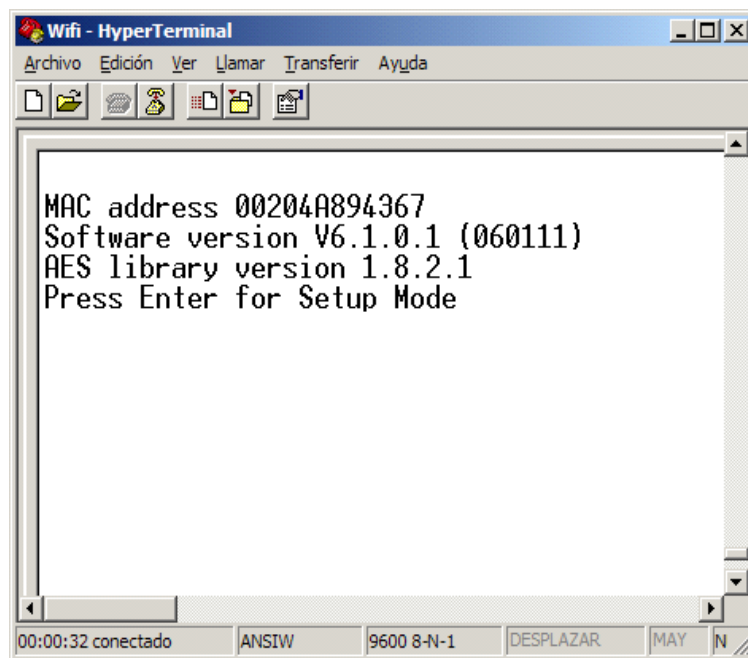

- 6– At this time you have **3 seconds** to push the Intro key on your keyboard .
7– The following screen is shown.

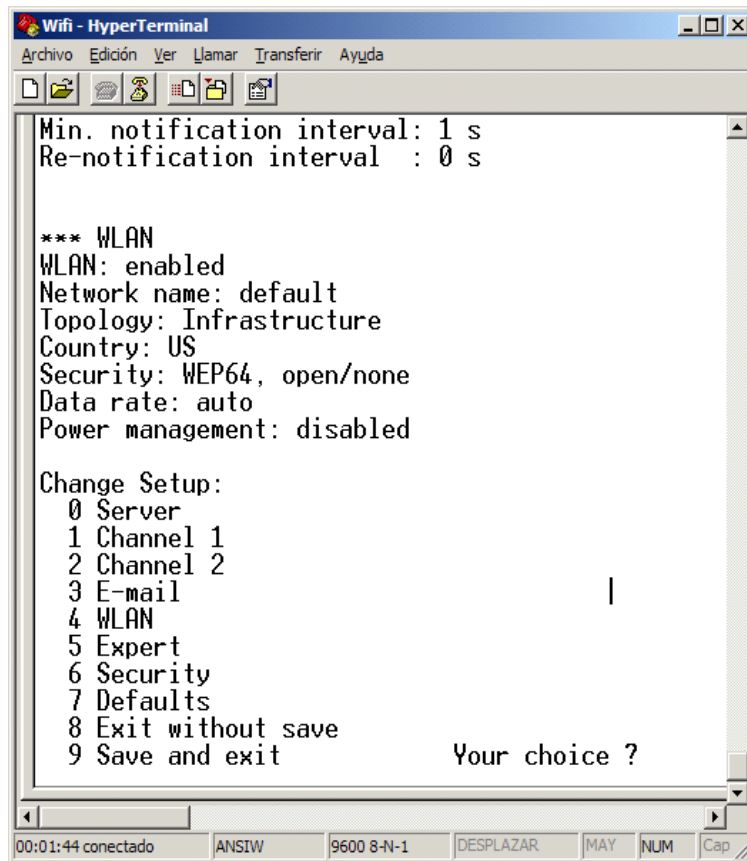

```
Wifi - HyperTerminal
Archivo Edición Ver Llamar Transferir Ayuda
Min. notification interval: 1 s
Re-notification interval : 0 s

*** WLAN
WLAN: enabled
Network name: default
Topology: Infrastructure
Country: US
Security: WEP64, open/none
Data rate: auto
Power management: disabled

Change Setup:
0 Server
1 Channel 1
2 Channel 2
3 E-mail
4 WLAN
5 Expert
6 Security
7 Defaults
8 Exit without save
9 Save and exit          Your choice ?

00:01:44 conectado  ANSIW  9600 8-N-1  DESPLAZAR  MAY  NUM  Cap
```

8- You must set up:

0 Server + Intro

4 WLAN + Intro

Example of Server Set up

Ask your network administrator the IP and Gateway address.

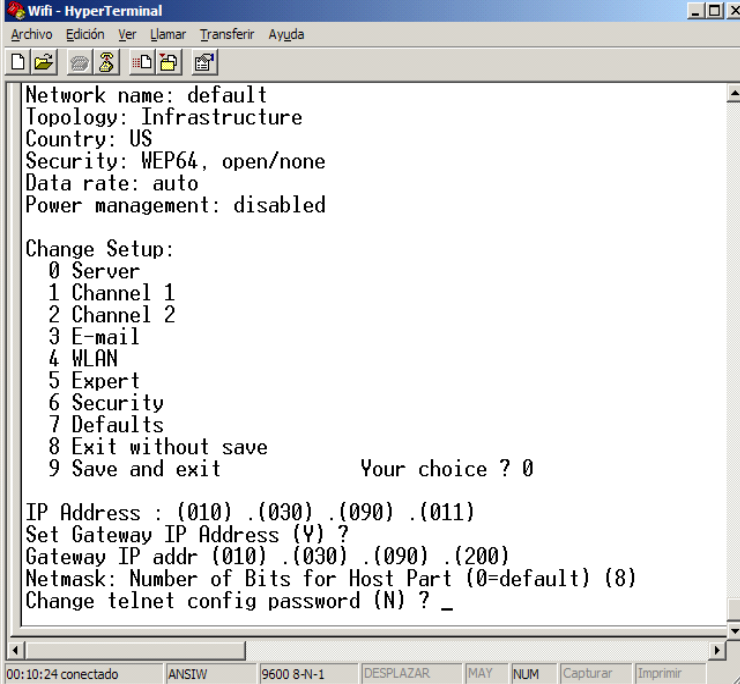

```

Wifi - HyperTerminal
Archivo Edición Ver Llamar Transferir Ayuda

Network name: default
Topology: Infrastructure
Country: US
Security: WEP64, open/none
Data rate: auto
Power management: disabled

Change Setup:
0 Server
1 Channel 1
2 Channel 2
3 E-mail
4 WLAN
5 Expert
6 Security
7 Defaults
8 Exit without save
9 Save and exit          Your choice ? 0

IP Address : (010) .(030) .(090) .(011)
Set Gateway IP Address (Y) ?
Gateway IP addr (010) .(030) .(090) .(200)
Netmask: Number of Bits for Host Part (0=default) (8)
Change telnet config password (N) ? _

00:10:24 conectado ANSIW 9600 8-N-1 DESPLAZAR MAY NUM Capturar Imprimir
  
```

Example of WLAN Set up

Ask your network administrator the correct values

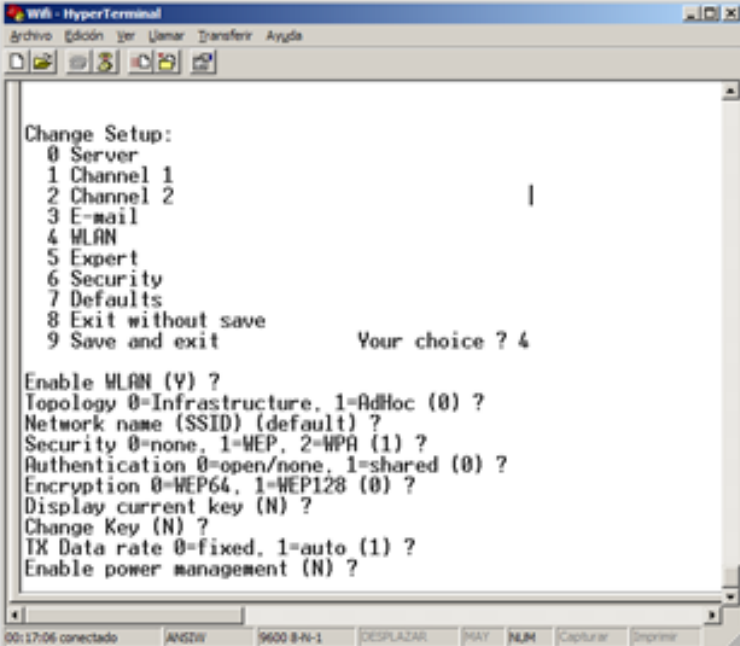

```

Wifi - HyperTerminal
Archivo Edición Ver Llamar Transferir Ayuda

Change Setup:
0 Server
1 Channel 1
2 Channel 2
3 E-mail
4 WLAN
5 Expert
6 Security
7 Defaults
8 Exit without save
9 Save and exit          Your choice ? 4

Enable WLAN (Y) ?
Topology 0=Infrastructure, 1=AdHoc (0) ?
Network name (SSID) (default) ?
Security 0=none, 1=WEP, 2=WPA (1) ?
Authentication 0=open/none, 1=shared (0) ?
Encryption 0=WEP64, 1=WEP128 (0) ?
Display current key (N) ?
Change Key (N) ?
TX Data rate 0=Fixed, 1=auto (1) ?
Enable power management (N) ?

00:17:06 conectado ANSIW 9600 8-N-1 DESPLAZAR MAY NUM Capturar Imprimir
  
```

To exit select 8 (Exit without save) or 9 (Save and exit).

4.6 Set up IP Address using the DeviceInstaller.

Before being able to communicate with the display, an IP address must be assigned. To assign an IP address, the DeviceInstaller program from Lantronix must be used, which can be downloaded free from their website: www.lantronix.com

Select: Support → Technical Support → Firmware/Downloads.

Select: DeviceInstaller.

Once the program is installed and running, press the “Search” button to locate the connected displays. The display must be turned on and connected to the network.

If there are no network problems, a screen similar to this should be displayed.

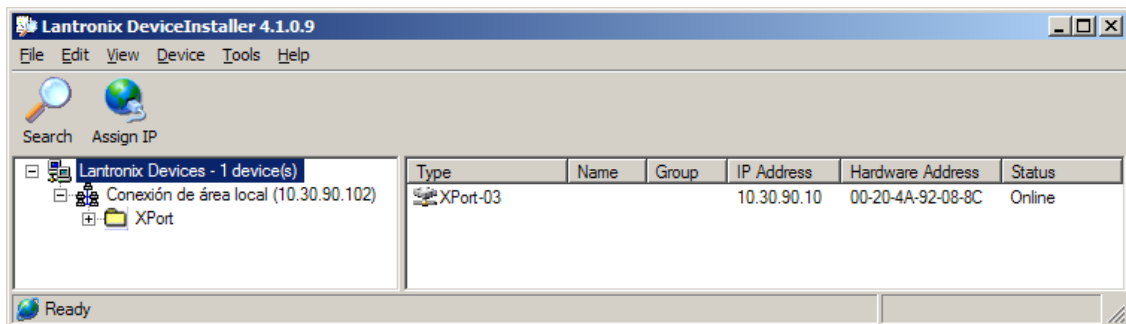

The IP address with which the equipment is supplied is: 10.30.90.10

The Hardware Address is the MAC code.

To assign the IP address you must first select the equipment by clicking on the XPort-03 to which you wish to assign the address. Then press Assign IP and follow the instructions.

IMPORTANT: All displays are dispatched from the factory with the same IP address. Therefore to configure various, they must be connected to the Ethernet and the address must be assigned one by one.

4.7 Modifying the port settings.

To modify the port configuration the DeviceInstaller program Lantronix must be used, which can be downloaded free from their website: www.lantronix.com

Select: Support → Technical Support → Firmware/Downloads.

Select: DeviceInstaller.

Once the programs is installed and running, press the Search button to locate the connected displays. The display must be turned on and connected to the network.

If there are no network problems, the same screen for configuring an IP address should be displayed. See 4.5 “IP Address”.

To access the setup you must first select the unit clicking on the XPort-03 that you wish to modify.

Then press Web Configuration and the GO key placed at the right side of IP address.

Enter your computer User Name and Password.

You will see a screen similar to the one below.

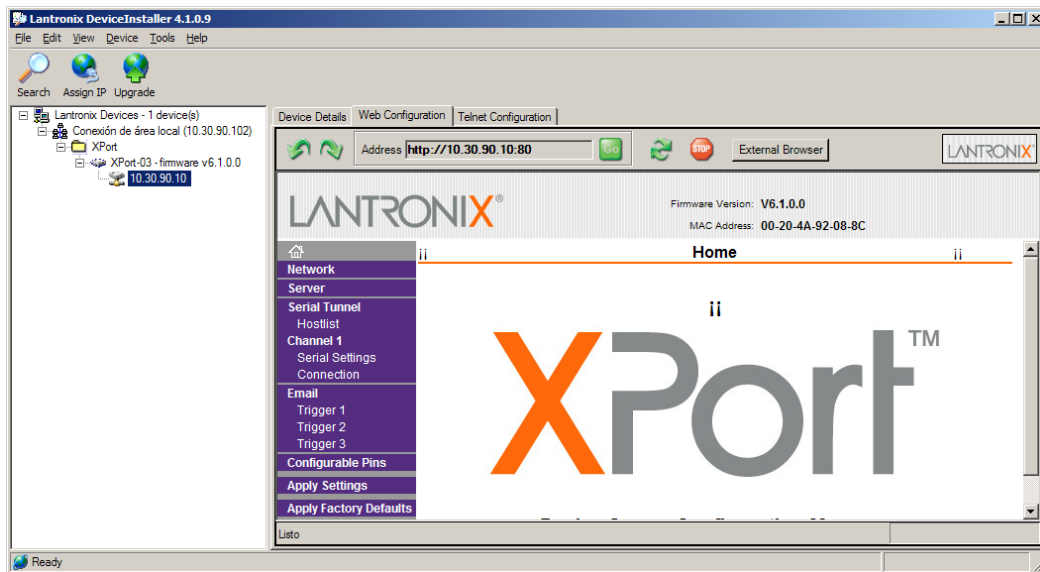

To access the setup the Local Port, select Channel1->Connection.
You will see a screen similar to the one below.

In Local Port insert the new value and click OK on the bottom of the page.

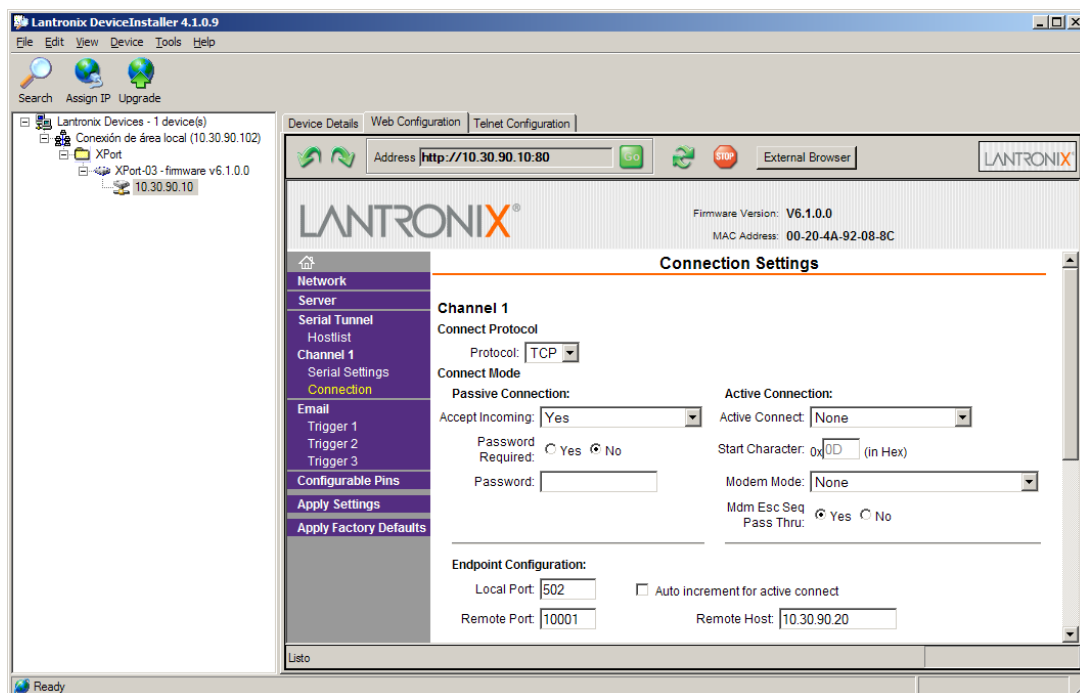

4.7.1 Configure to use the UDP/IP protocol

To access the setup the Local Port, select **Channel1->Connection**.

Select the protocol: UDP in Connect Protocol.

Select **Datagram Type = 1** in Datagram Mode.

In Endpoint Configuration set:

Local Port = 10001

Remote Host: IP address of the computer to which it is connected.

Remote Port: Port of the computer to which it is connected.

Click **OK** on the bottom of the page.

Click **Apply Settings** on the menu.

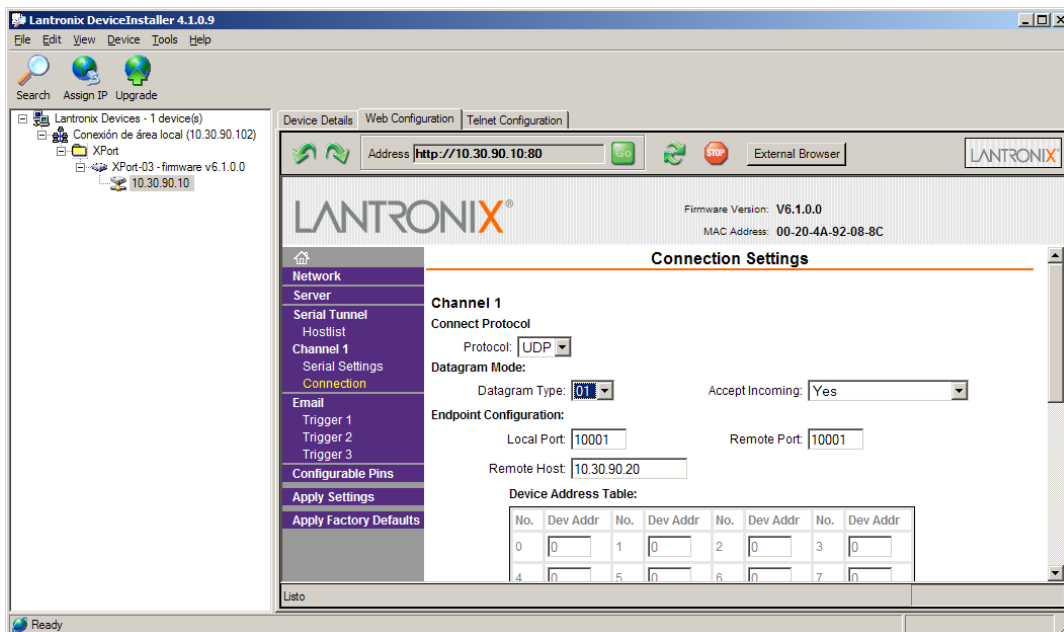

Protocols

TCP/IP and UDP/IP local port = 10001

Modbus/TCP local port = 502

4.7.2 Configure to use the Modbus/TCP protocol

To use the Modbus protocol is recommended to set **Enable Packing** bit. Follow the steps below:

On the left side, menu selects **Channel 1-> Serial Settings**.

Set **Enable Packing** bit in the **Pack Control** area.

Click **OK** on the bottom of the page.

Click **Apply Settings** on the menu.

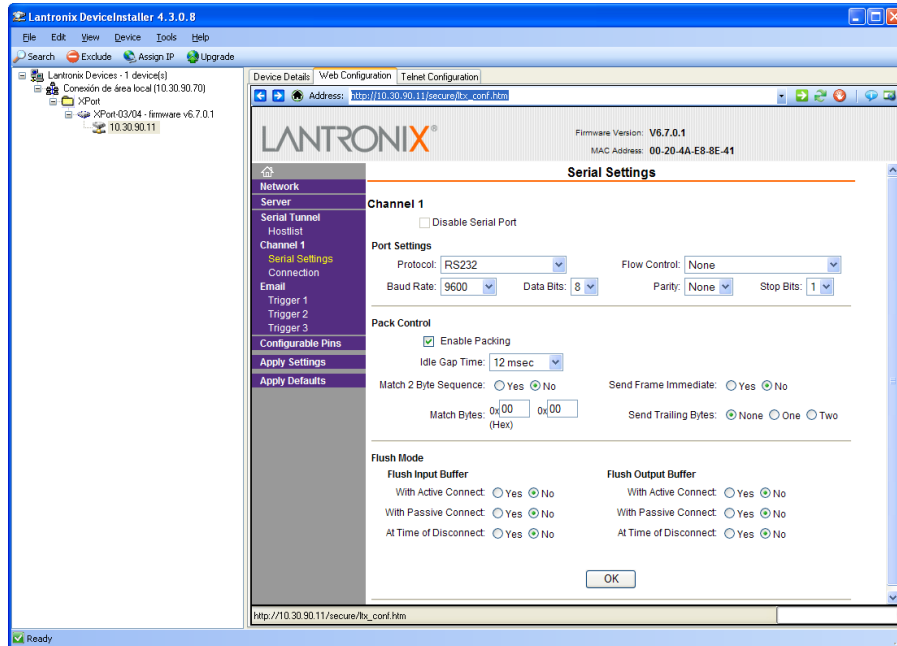

In order to check **Enable Packing** bit setting, you must exit the Web Configuration page and re-enter. Click **Search** on the menu and enter again into the Web Configuration.

Remember to set the Local Port to 502.

STATEMENT OF CONFORMITY



Tetralec Electronica Industrial S.L.
c/ Severo Ochoa, 80
Polígono Industrial Font del Radium
08403 Granollers

As the builder of the equipment of the brand **LARTET**:

DT-203NW in all versions.
DT-105NW in all versions.
DT-110NW in all versions.

We declare under our sole responsibility that the aforementioned product complies with the following European directives:

Directive: LVD 2006/95/CEE Low Voltage Directive.
Standard UNE-EN61010-1 Security in electric equipment.

Directive: EMC 2014/30 UE Electromagnetic Compatibility
Standard UNE-EN 61000-6-4 Generic Emission Standard. Industrial environment.
Standard UNE-EN 61000-6-2 Generic Immunity Standard. Industrial environment.
Directive 2011/65/CE: Restriction of the use of certain hazardous substances in
electrical and electronic equipment

Granollers, February 13th 2017